

SCAN ME

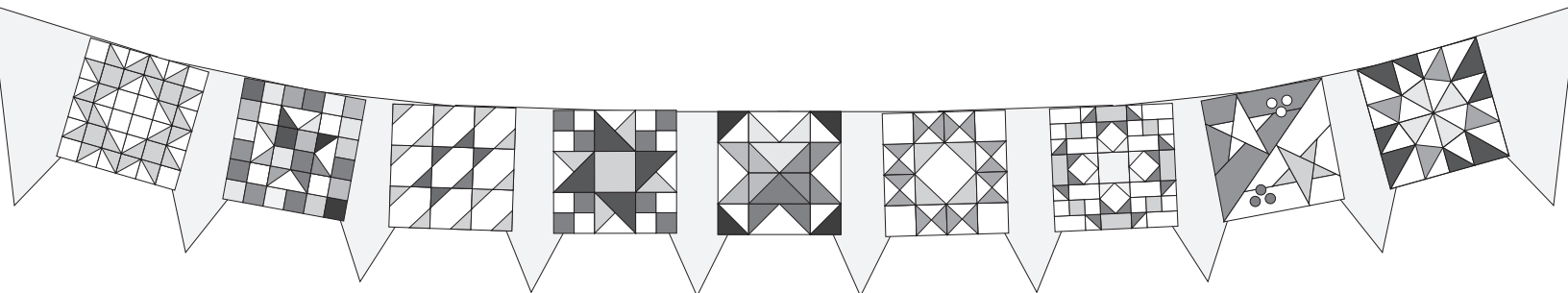







## ***Festive Blockheads Bunting***

by Moda Fabrics

Bunting, pennants, garland, swag — whatever you prefer to call it, this fun decoration is a great way to show off your 6" blocks and celebrate a favorite season or special day!

**8 ½" x 92" (approx.) finished, using 9 blocks**

### **Block and Fabric Requirements**

-  (9) 6" finished blocks
-  (10) assorted 10" squares for bunting pennants
-  ¾ yard backing fabric for blocks
-  ⅛ yard coordinating fabric for bunting tie
-  **Recommended:** Jen Kingwell 10" Bunting Tool
-  **Recommended:** Clover 18mm (¾") Bias Tape Maker

### **Cutting Instructions**

From block backing fabric	
9	6 ½" squares
From bunting tie fabric	
3	1 ½" x WOF strips

### **Before You Start Sewing...**

Decide which side of your Blockheads block is going to be the top of the block, and mark the top with a pin or clip, if necessary.

Do this for all 9 blocks.

Mark the top of your blocks  
with a pin or clip

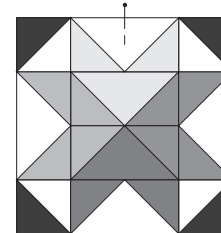



## Assembly Instructions

### Step 1

Place a pieced block and a 6 ½" block backing square right sides together, making sure the top of your block is oriented correctly. Using a ¼" seam, stitch along the sides and bottom of the block and backing, leaving the top open. (It will be enclosed in the bunting tie later.)

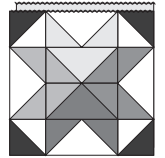
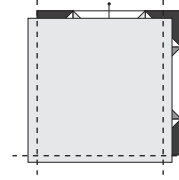

### Step 2

Turn the block right side out through the open side. Press. Repeat for the remaining blocks.

### Step 3

Follow the instructions for Jen Kingwell's 10" bunting tool to cut (10) bunting triangles. If you do not have the bunting tool, you can use your straight ruler to cut the triangles:

Fold a 10" square in half diagonally (bottom right corner to top left corner), right sides together. Align the folded edge along the bottom horizontal line of your cutting mat as shown.

Align your ruler at the top point of the folded square at the 7" mark and at the bottom folded edge on the horizontal line at the 10" mark as shown, and cut.

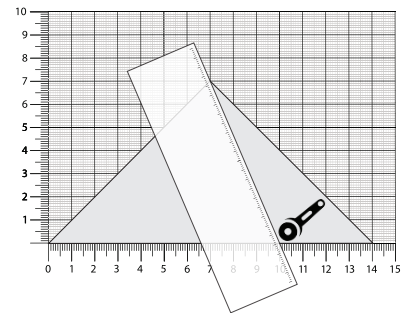
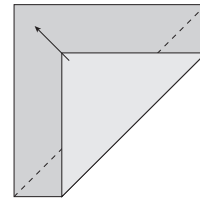

### Step 4

Fold a bunting triangle right sides together. Using a ¼" seam, stitch along the long edge opposite the fold. Do not stitch across the top. Turn pennant right-side out and press.

Repeat to make 10 bunting pennants.

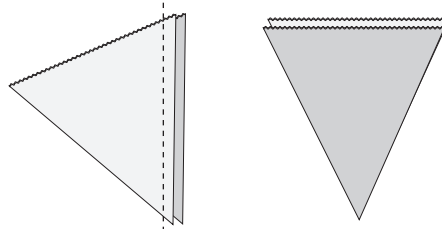

### Step 5

Sew the 1 ½" bunting tie strips together end to end to create one long strip. Follow instructions for the Clover bias tape maker to press the strip into double-fold tape. If you do not have a bias tape maker, you can make double-fold tape using this method:

Fold the strip in half lengthwise, wrong sides together. Press.



Unfold, bring the raw lengthwise edges of the strip in to meet at the center fold line, and press.



Fold the strip in half again, lengthwise and along the original fold line, so that the raw edges are inside. Press.





### Step 7

Unfold the bias tape once. Leaving about 10" of length for tying your bunting, place one bunting pennant so that the raw top edge is aligned with the center fold line of the bias tape.

Using a ¼" seam and a long stitch length, baste in place.

### Step 8

Place the next bunting pennant about 2" from the first pennant and baste.

Continue basting the pennants in place, leaving about 2" between each one.

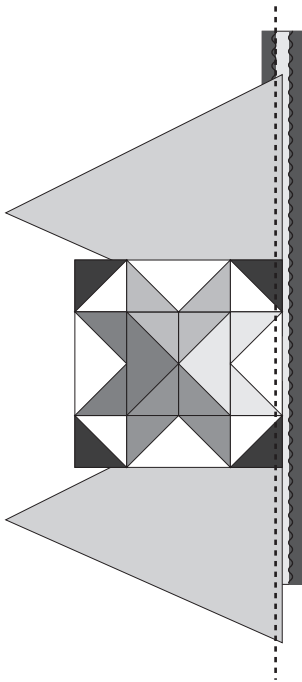
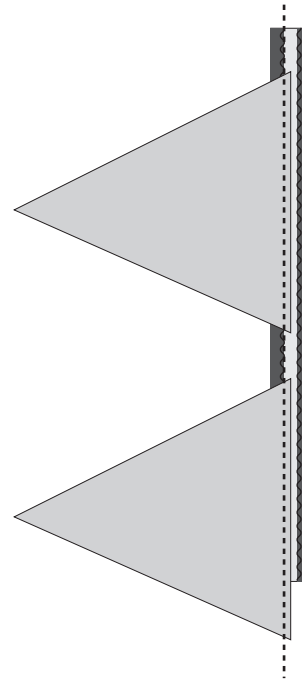

### Step 9

Center a pieced block between the first two pennants, making sure the raw top edge is aligned with the center fold line of the bias tape, and baste.

Continue basting the pieced blocks in place, centering each block between two pennants.

### Step 10

Fold the short ends of the bias tape in about ¼" and stitch, so your bunting tie doesn't have frayed ends.

Fold the bias tape in half, enclosing the raw top edges of the pennants and blocks, and stitch the bias tape down from end to end using a short stitch length and keeping the seam close to the bottom edge of the bias tape.

*Tip: It might be helpful to glue baste the bias tape down first.*

